

# Ventilation system

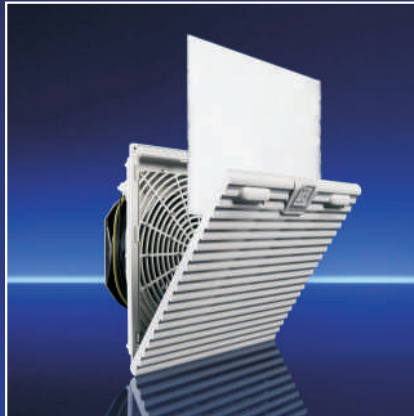

# ventilation system

## Wall ventilation system

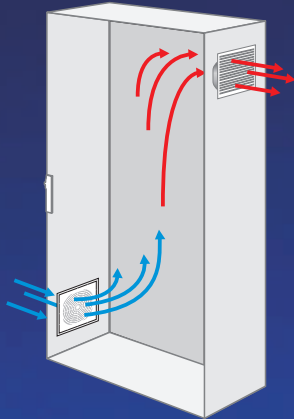

**Aria** - page 140  
a complete range of fans and filters for electric boards heat exchange.  
Quick snap-mounting system; hinged front.  
Polyurethane sealing gaskets.

## Roof ventilation system

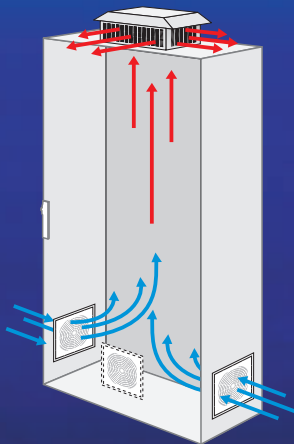

**ZTE tower** - page 142  
extracting tower for electric boards heat exchange.  
Finned lower base and centrifugal fan.  
Polyurethane sealing gaskets.

# wall ventilation system



Fans and filters for air exchange for electric boards. Designed and produced in Italy; characterized by a quick snap-mounting system and a hinged front grid to make cloth filter cleaning/replacement more rapid; motors installed on bearings; more than 40.000h reliability; polyurethane sealing gaskets.

**Material:**  
ABS UL94-V0 prot. UVA

**Approvals:**

RoHS 2011/65/CE

REACH 1272/2008/CE

CE EN 62 208 • EN 61 439-1



TYPE 1, 12 • Standard 508  
NEMA 1, 12 • Standard 250  
FILE NR. E 238294



IP54 EN 62 208 • EN 61 439-1  
IK08 EN 62 208 • EN 61 439-1

## 200m<sup>3</sup>/h Ventilation

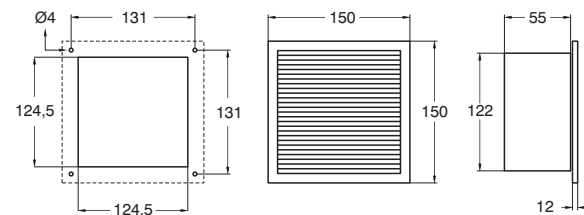

### 200m<sup>3</sup>/h ventilation set

Description	Order code	Pack	Rated operational voltage	Rated operational current	Power consumption	Noise level	Air flow (free intake)	Air flow with filter set (filter included)	Operation temperature	Kg	m <sup>3</sup>
Fan with filter	<b>ARIA-V150-1.</b>	1	230, 1~,50/60	0,14/0,12	22/21	45/50	200	156/150	da -10 a +70	0,8	0,01
Fan with filter	<b>ARIA-V150-2.</b>	1	115, 1~,50/60	0,26/0,24	22/20	45/50	200	156/150	da -10 a +70	0,8	0,01
Fan with filter	<b>ARIA-V150-3.</b>	1	24 (DC)	0,40	9,6	48	235	176	da -10 a +70	0,8	0,01
Fan with filter	<b>ARIA-V150-4.</b>	1	24 (AC) - 60	0,70	11	47	165	128	da -10 a +70	0,8	0,01
Outlet filter	<b>ARIA-F150.</b>	1	-	-	-	-	-	-	da -30 a +80	0,2	0,01

ADD **G - W - B - C - S** EXTENSION AFTER THE POINT TO COMPLETE ORDER CODE

ADD **-UL** EXTENSION AFTER COLOUR ABBREVIATION TO COMPLETE ORDER CODE (Ex. **ARIA-V150-1.G-UL**)

## 340/520m<sup>3</sup>/h Ventilation

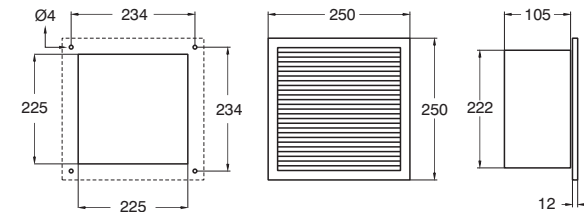

### 340/520m<sup>3</sup>/h ventilation set

Description	Order code	Pack	Rated operational voltage	Rated operational current	Power consumption	Noise level	Air flow (free intake)	Air flow with filter set (filter included)	Operation temperature	Kg	m <sup>3</sup>
Fan with filter	<b>ARIA-V250-1.</b>	1	230, 1~,50/60	0,28/0,24	25/26	51/55	340	265/244	da -10 a +80	1,7	0,01
Fan with filter	<b>ARIA-V250-2.</b>	1	115, 1~,50/60	0,65/0,54	22/20	52/55	340	265/244	da -10 a +80	1,7	0,01
Outlet filter	<b>ARIA-F250.</b>	1	-	-	-	-	-	-	da -30 a +80	0,5	0,01

ADD **G - W - B - C - S** EXTENSION AFTER THE POINT TO COMPLETE ORDER CODE

ADD **-UL** EXTENSION AFTER COLOUR ABBREVIATION TO COMPLETE ORDER CODE (Ex. **ARIA-V150-1.G-UL**)



# wall ventilation system

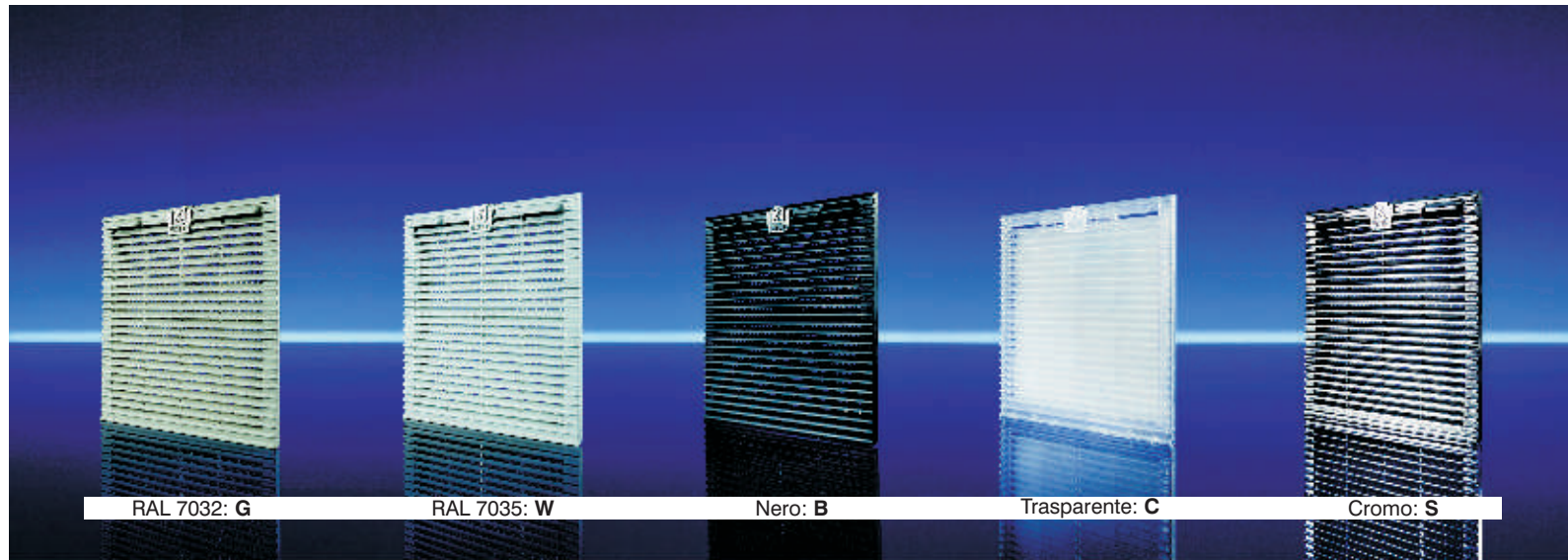

G - W - B - C - S EXTENSIONS DEFINE THE COLOUR OF THE FILTER.  
 -UL EXTENSION DEFINES THE MARK OF THE COLOUR (Ex. ARIA-F150.G-UL)

## 800/1000m<sup>3</sup>/h Ventilation

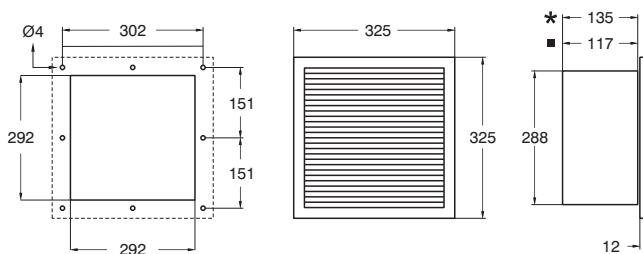

### 800/1000m<sup>3</sup>/h ventilation set

Description	Order code	Pack	Rated operational voltage	Rated operational current	Power consumption	Noise level	Air flow (free intake)	Air flow with filter set (filter included)	Operation temperature	Kg	m <sup>3</sup>
			V-ph-Hz	A	W	dB (A)	m <sup>3</sup> /h	m <sup>3</sup> /h	°C		
★ Fan with filter	ARIA-V325-1.	1	230, 1~.50/60	0,29/0,33	62/75	59/61	1000	780/790	da -15 a +55	2,5	0,02
■ Fan with filter	ARIA-V325-2.	1	230, 1~.50/60	0,20/0,22	55/50	65/70	800	624/632	da -15 a +55	2,5	0,02
★ Fan with filter	ARIA-V325-3.	1	115, 1~.50/60	0,58/0,70	64/80	66/62	1000	780/790	da -15 a +55	2,5	0,02
Outlet filter	ARIA-F325.	1	-	-	-	-	-	-	da -15 a +55	0,8	0,01

ADD G - W - B - C - S EXTENSION AFTER THE POINT TO COMPLETE ORDER CODE

ADD -UL EXTENSION AFTER COLOUR ABBREVIATION TO COMPLETE ORDER CODE (Ex. ARIA-V150-1.G-UL)

## 1 HE - 486/972 m<sup>3</sup>/h drawer-mounted fans

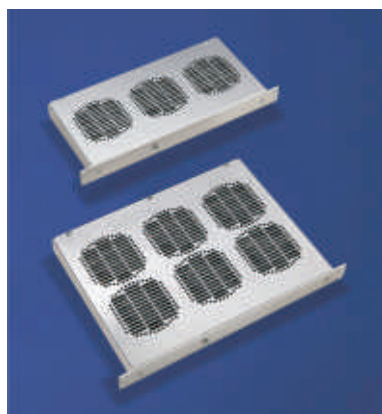

An efficient quick-insert fan system which optimize and uniform electric-board and 19" rack data server heat exchange. Provided with front warning led and back power connector.

**Material:** 1,5/2 mm thick anodized aluminium.

### Approvals:

IP20 EN 62 208 • EN 61 439-1  
 IK08 EN 62 208 • EN 61 439-1

TYPE 1 • Standard 508  
 NEMA 1 • Standard 250

CE EN 62 208 • EN 61 439-1

2011/65/CE

1272/2008/CE

### 1 HE drawer-mounted fan for Rack 19"

Description	Order code	Pack	Rated operational voltage	Power consumption	Air flow	Operation temperature	Dimensions WxD	Height 1HE
			V-ph-Hz	W	m <sup>3</sup> /h	°C	mm	mm
3 fan drawer	VE3322	1	230, 1~.50/60	45	486	da -10+70	430 x 208	43,6
6 fan drawer	VE6622	1	230, 1~.50/60	90	972	da -10+70	430 x 330	43,6

115 VA AND 24 VDC AVAILABLE ON REQUEST

# roof ventilation system

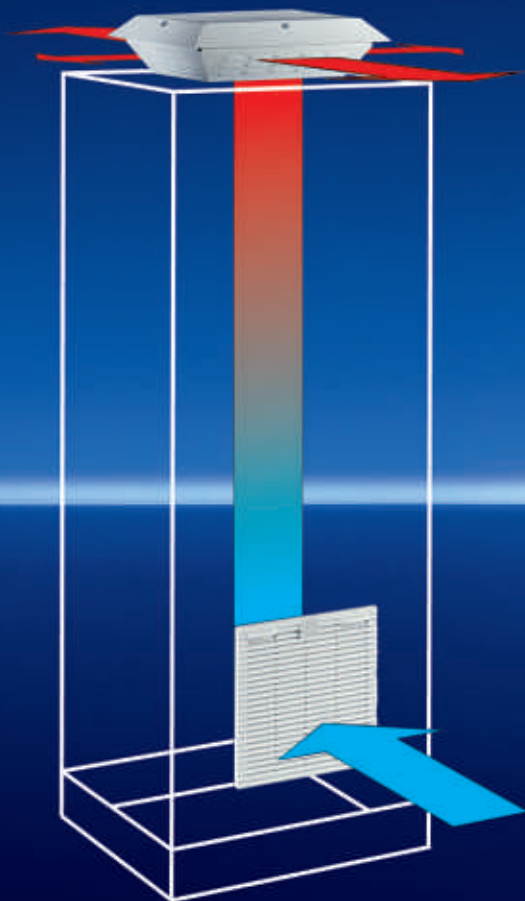

## Roof ventilation system:

Towers with no maintenance needs, for electric boards air exchange/extraction. Designed and produced in Italy; characterized by steel sheet housings and finned lower base; high-head centrifugal-fans generated flow; more than 40.000h reliability; terminal box connection; polyurethane sealing gaskets. All the articles are ready to be installed and provided with mounting screws. Available in RAL7032 and RAL7035 textured. Combine towers to ARIA-F150, ARIA-F250 and ARIA-F325 inlet filters at page 138-139, to create ventilation systems, according to the following table:

## Painting:

Thermosetting powders.

## Material:

1,5 mm thick carbon steel. 1,5 mm thick AISI 304 stainless-steel. Fine scotch brite medium satin, 240 grit. In AISI 316 stainless-steel on request.

## Standard colours:

RAL7035 textured  
RAL7032 on request

## Approvals:

IP43 EN 62 208 • EN 61 439-1  
IK10 EN 62 208 • EN 61 439-1

EN 62 208 • EN 61 439-1

TYPE 1 • Standard 508  
NEMA 1 • Standard 250  
FILE NR. E 238294

2011/65/CE

1272/2008/CE

Order code	Grid number	Grid combination	Air flow with filter set	
			m³/h	m³/h
ZTE600	3	ARIA-F150	468	
ZTE600	2	ARIA-F250	530	
ZTE600	1	ARIA-F325	540	
ZTE1000	5	ARIA-F150	780	
ZTE1000	3	ARIA-F250	795	
ZTE1000	2	ARIA-F325	780	
ZTE1500	8	ARIA-F150	1248	
ZTE1500	4	ARIA-F250	1150	
ZTE1500	2	ARIA-F325	1170	
ZTE2100	5	ARIA-F250	1435	
ZTE2100	3	ARIA-F325	1638	
ZTE3000	8	ARIA-F250	2130	
ZTE3000	4	ARIA-F325	2150	
ZTE4000	6	ARIA-F325	2390	

## 600/1000 m³/h roof ventilation systems

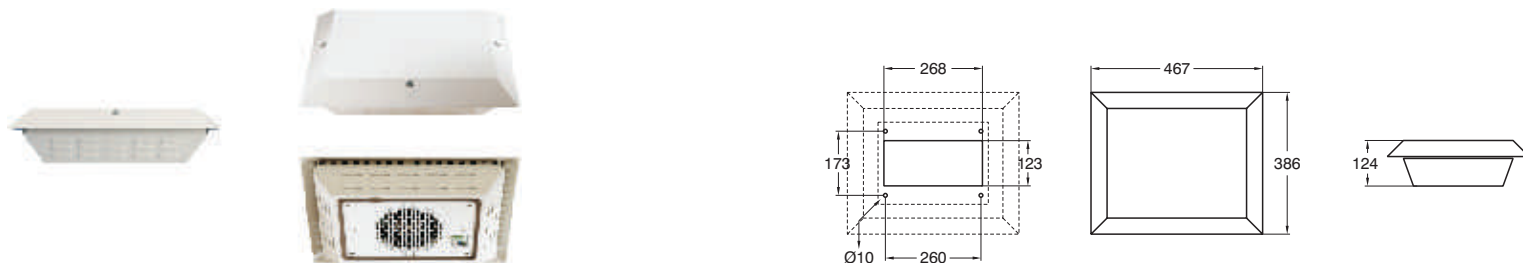

## 600/1000 m³/h roof ventilation systems

Description	Order code	Pack	Rated operational voltage	Rated operational current	Power consumption	Noise level	Capacitor	Air flow (free intake)	Operation temperature		
External-protection fan	ZTE600-1.X	1	230, 1~,50/60	0,30	70	71/72	2-450	600	da 0 a +70	10,4	0,03
External-protection fan	ZTE600-2.X	1	115, 1~,60/50	0,80	90	71/72	5-370	600	da 0 a +70	10,4	0,03
External-protection fan	ZTE1000-1.X	1	230, 1~,50/60	0,53/0,75	118/170	72/71	5-450	1000	da 0 a +70	10,6	0,03
External-protection fan	ZTE1000-2.X	1	110, 1~,50	1,13	120	72/71	20-250	1000	da 0 a +70	10,6	0,03
External-protection fan	ZTE600-1.X-UL	1	230,1~,50/60	0,30	70	71/72	2-450	600	da 0 a +70	10,4	0,03
External-protection fan	ZTE600-2.X-UL	1	115,1~,60/50	0,80	90	71/72	5-370	600	da 0 a +70	10,4	0,03
External-protection fan	ZTE1000-1.X-UL	1	230,1~,50/60	0,75	170	72/71	5-440	1000	da 0 a +70	10,6	0,03
External-protection fan	ZTE1000-2.X-UL	1	115~,60/50	1,5	170	72/71	20-250	1000	da 0 a +70	10,6	0,03

SUBSTITUTE X with: **G** for RAL7032; **W** for RAL7035; **A** for stainless-steel.

technical data subject to change without notice

# roof ventilation system

## 1500/2100 m<sup>3</sup>/h roof ventilation systems

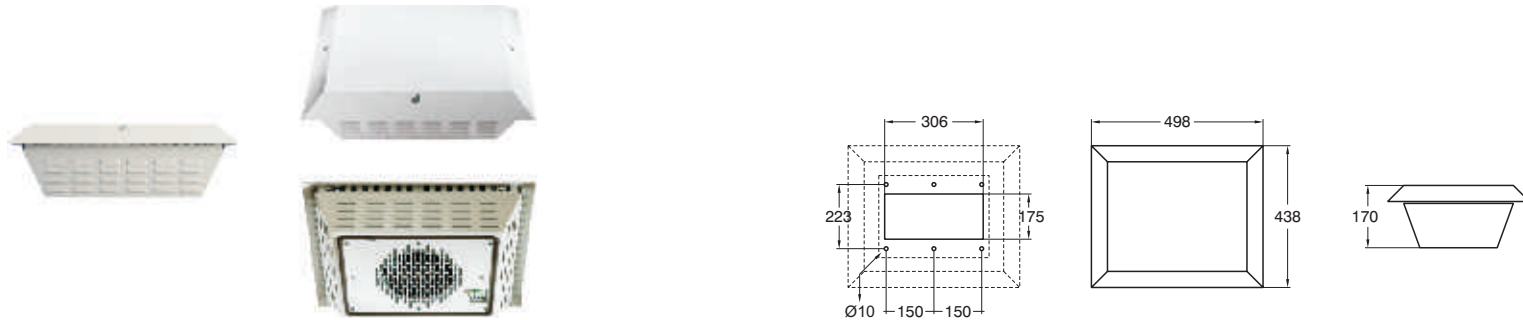

### 1500/2100 m<sup>3</sup>/h roof ventilation systems

Description	Order code	Pack	Rated operational voltage	Rated operational current	Power consumption	Noise level	Capacitor	Air flow (free intake)	Operation temperature	Kg	m <sup>3</sup>
External-protection fan	ZTE1500-1.X	1	230, 1~.50	0,73	165	74/75	5-450	1500	da 0 a +70	13,4	0,04
External-protection fan	ZTE1500-2.X	1	115, 1~.60	1,96	215	75	20-370	1500	da 0 a +70	13,4	0,04
External-protection fan	ZTE1500-2.X-UL	1	115, 1~.60	1,96	215	75	20-370	1500	da 0 a +70	13,4	0,04
External-protection fan	ZTE2100-1.X	1	230, 1~.50	1,00	240	78	8-450	2100	da 0 a +70	14	0,04

SUBSTITUTE X with: **G** for RAL7032; **W** for RAL7035; **A** for stainless-steel.

## 2800/3100 m<sup>3</sup>/h roof ventilation systems

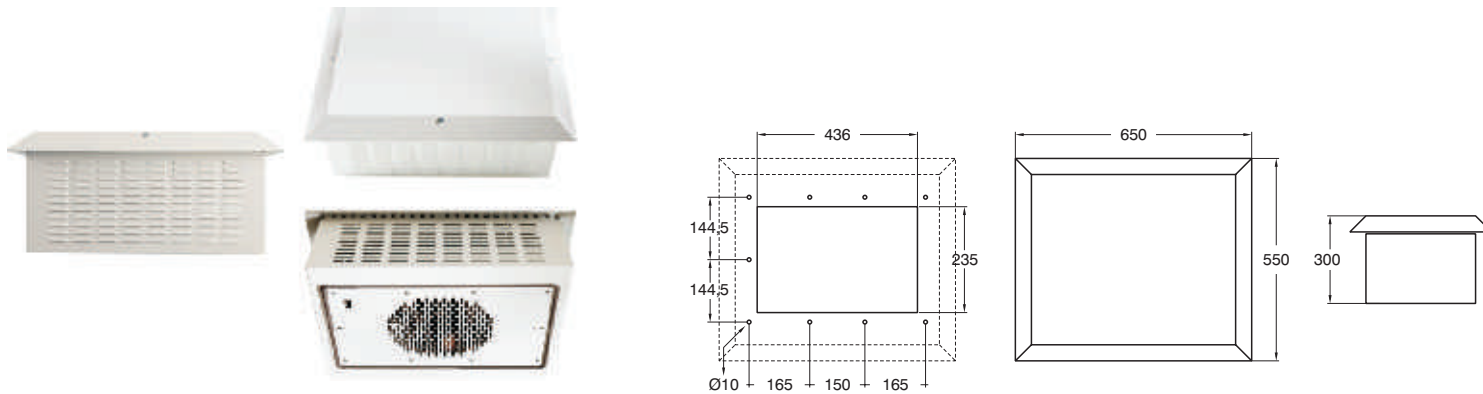

### 2800/3100 m<sup>3</sup>/h roof ventilation systems

Description	Order code	Pack	Rated operational voltage	Rated operational current	Power consumption	Noise level	Capacitor	Air flow (free intake)	Operation temperature	Kg	m <sup>3</sup>
External-protection fan	ZTE3000-1.X	1	230, 1~.50/60	1,20	300	69	12-400	2800	da 0 a +70	29,3	0,12
External-protection fan	ZTE4000-1.X	1	230, 1~.50/60	1,20	300	78	12-400	3100	da 0 a +70	31,5	0,12

SUBSTITUTE X with: **G** for RAL7032; **W** for RAL7035; **A** for stainless-steel.

## Ventilation chimneys



To be installed on cabinets roof to create a natural or a forced convective thermal system.

**Painting:**  
Thermosetting powders.

**Material:**  
1,5 mm thick steel sheet.

**Standard colours:**  
RAL7035 textured  
RAL7032 on request

**Degree of Protection:**  
IP54 EN 60529  
IK10 EN 62262

### Ventilation chimneys

DIMENSION	360 x 360 x 80	560 x 360 x 80	760 x 360 x 80	960 x 360 x 80
Steel Code	C1.35	C2.35	C3.35	C4.35
Stainless-steel Code	C1A	C2A	C3A	C4A

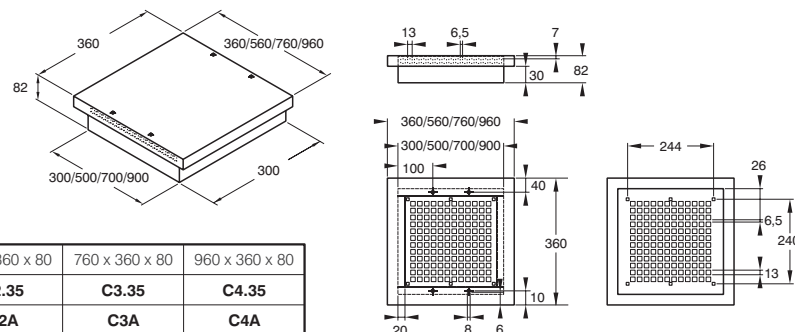

technical data subject to change without notice

# ventilation system accessories



**Anti-condensation heaters:** for carpentry thermoregulation. The aluminium-profile structure generates a draught effect which allows a uniform distribution of temperature in the carpentry. Heaters are designed for permanent operation.

**Rated voltage:** 120-240V AC/DC\* (min.110V - max 265V).  
**Heating element:** PTC thermistor, temperature restriction.  
**Radiator:** Anodised aluminium profile  
**Connection:** 3 flexible pressure clamps for conductor (with 0,5-1,5 sqmm terminal)  
**Connection box:** UL94-V-0 plastic, black.

**Fixing:** Clip for 35 mm DIN guide, EN60715.  
**Installation position:** Vertical (airflow on top/bottom connection).  
**Operation environment temperature:** -45°C - +70°C (-49°F - +158°F).  
**Protection class:** IP20/I (earthed protective conductor).  
**Approvals:** CE - VDE - UL File E150057.

#### Anti-condensation heaters

DIMENSIONS mm	H109xW70xD60	H109xW70xD60	H109xW70xD60	H184xW70xD60	H184xW70xD60	H264xW70xD60	
DESCRIPTION	15W	30W	45W	75W	100W	150W	1-piece pack
Code	VR1415	VR1430	VR1445	VR1475	VR14100	VR14150	



**SMALL anti-condensation heaters** for carpentry thermoregulation.

**Rated voltage:** 120-240V AC/DC\* (min.110V - max 265V).  
**Heating element:** PTC thermistor, temperature restriction.  
**Radiator:** Anodised aluminium profile  
**Fixing:** Clip for 35 mm DIN guide, EN60715.

**Installation position:** Vertical (airflow on top/bottom connection).  
**Operation environment temperature:** -45°C - +70°C (-49°F - +158°F).  
**Protection class:** IP44/I (earthed protective conductor).  
**Approvals:** CE - VDE - UL File E150057.

#### Anti-condensation heaters

DIMENSIONS mm	H62xW50xD25	H72xW50xD25	H82xW50xD25				
DESCRIPTION	10W with cable	20W with cable	30W with cable				1-piece pack
Code	VR4710	VR4720	VR4730				



**Anti-condensation heating fan** to prevent excessive cooling. The integrated axial-flow fan guarantees forced air circulation, by uniforming the temperature in the carpentry. Connection with an internal clamp. Provided with a temperature monitoring device for overheating protection in case of fan malfunctioning.

**Rated voltage:** 230 V AC 50/60Hz.  
**Heating element:** Resistance heating.  
**Temperature monitoring device:** Overheating protection in case of fan malfunctioning.  
**Radiator:** Anodised aluminium profile  
**Surface temperature:** Max 75°C (400 W).  
**Axial-flow fan:** Capacity, free aeration.  
**Ball-bearing installation:** capacity: 45mc/h(50Hz) or 54mc/h(60Hz). DC capacity: 54mc/h. Lenght: 50.000h at 25° (77°F).

**Connection:** internal connection clamp, 1,5 sqmm, anti-traction device max 0,8 Nm tightening torque.  
**Connection box:** UL94-V-0 plastic, black.  
**Fixing:** Clip for 35 mm DIN guide, EN60715.  
**Installation position:** Vertical (airflow on top).  
**Operation environment temperature:** -45°C - +70°C (-49°F - +158°F).  
**Protection class:** IP20/I (earthed protective conductor).  
**Approvals:** CE - VDE - UL File E150057.

#### Anti-condensation heaters WITH FANS

DIMENSIONS mm	H178xW80xD80	H252xW80xD80					
DESCRIPTION	250W with fan	400W with fan					1-piece pack
Code	VR46250	VR46400					



**Protective casing:** filters and fans protection device for a higher protection level; for 150x150 mm, 250x250 mm and 325x325 mm filters/fans, with bottom airflow.

**Material:** 15/10 thick steel sheet, thermosetting powders painted.  
**Colours:** RAL7035 textured - RAL7032 textured on request.

**Material:** 15/10 thick AISI 304 stainless-steel sheet  
**Finish:** Fine scotch brite medium satin

#### Protective casing in:

Painted Sheet

Stainless-steel

DIMENSIONS mm	H222xW200xD42	H343xW330xD54	H415xW390xD60	1-piece pack	DIMENSIONS mm	H222xW200xD42	H343xW330xD54	H415xW390xD60	1-piece pack
Code	VE1300.35	VE2500.35	VE3500.35		Code	VE1300A	VE2500A	VE3500A	



**Replacement cloth filter:** small mesh cloth; it withstands up to 100° C. Contaminated air side: open structure. Clean air side: closed structure. It filters almost every type of dust with a grain size higher than 10 µm.

**Filter class:** G3 EN779  
**Filtering element:** in polyester fibre, class 1 DIN 53.438

#### Cloth filter

DIMENSIONS mm	SMALL cloth filter H114 x W114 x D8	MEDIUM cloth filter H214 x W199 x D8	LARGE cloth filter H282 x W273 x D8	1-piece pack
Code	F1515	F2525	F3535	



# ventilation system accessories

**Mechanical thermostats** for fans and signaling elements. Through temperature measurement, the thermostat controls resistive and inductive loads. If the fixed temperature is equal to the higher switching point value, the NC contact opens. If the fixed temperature, hysteresis (and tolerance) deducted, is equal to the lower switching point value, the NC contact closes.

<b>Switching hysteresis:</b>	5 K (tolerance value -3/+2 K).	<b>Max ign. Current:</b>	10 A AC for 10 sec.
<b>Sensor:</b>	Bimetal.	<b>Connection:</b>	4-pin clamp, 2,5 sqmm rigid wire, max tightening torque 0,5 Nm.max 0,5 Nm.
<b>Contact type:</b>	exchange contact (with snap-acting contacts)	<b>Fixing:</b>	Clip for 35 mm DIN guide, EN60715
<b>Switching current:</b>	10 mA.	<b>Housing:</b>	UL94-V-0 plastic, grey.
<b>Max breaking capacity:</b>	250 A AC. 10 (4)A.	<b>Dimensions and weight:</b>	H67 x L50 x P38 mm - 0,1 Kg.
<b>Breaking contact:</b>	120 V AC. 10 (4)A - 30 W DC.	<b>Working temperature:</b>	-45°C - +65°C (-49°F - +149°F).
<b>Max breaking capacity:</b>	250 A AC. 5 (2)A.	<b>Protection class:</b>	IP20.
<b>Closing contact:</b>	120 V AC. 5 (2)A - 30 W DC.	<b>Approvals:</b>	CE - VDE - UL File E164102.

## Thermostats

DESCRIPTION	4-pin therm. N/C-N/A			1-piece pack
Code	VR1060			



**Thermostats:** Art. **VR0601** - NC Contact for heating devices adjustment.  
Art. **VR0602** - NO contact for cooling devices, fans and exchangers adjustment.

<b>Switching hysteresis:</b>	5 K (tolerance value +-4K).	<b>Fixing:</b>	Clip for 35 mm DIN guide, EN60715
<b>Sensor:</b>	Bimetal.	<b>Housing:</b>	UL94-V-0 plastic, grey.
<b>Contact type:</b>	snap-acting contacts.	<b>Dimensions and weight:</b>	H60 x L33 x P43 mm - 40 g.
<b>Max breaking capacity:</b>	250 A AC. 10 (2)A.	<b>Working temperature:</b>	-45°C - +80°C (-49°F - +176°F).
<b>Breaking contact:</b>	120 V AC. 15 (2)A - 30 W DC.	<b>Protection class:</b>	IP20.
<b>Max ignition current:</b>	16 A AC for 10 sec.	<b>Approvals:</b>	CE - VDE - UL File E164102.
<b>Connection:</b>			

## Thermostats

DESCRIPTION	2-pin therm. NC	2-pin therm. NO		1-piece pack
Code	VR0601	VR0602		



**Mechanic humidistat.** It measures air humidity in metallic carpentries. Once the pre-fixed humidity value is reached, it turns on the heating system to avoid condensation on electric and electronic components.

<b>Hysteresis (relative humidity):</b>	4% RH (tolerance +-3%).	<b>Fixing:</b>	Clip for 35 mm DIN guide, EN60715
<b>Max acceptable air speed:</b>	15 m/s.	<b>Housing:</b>	UL94-V-0 plastic, grey.
<b>Contact type:</b>	exchange contact (with snap-acting contacts).	<b>Dimensions and weight:</b>	H67 x L50 x P38 mm - 60 g.
<b>Min breaking capacity:</b>	20 VAC/DC. 100 mA.	<b>Working environment temperature:</b>	-0°C - +60°C (+32°F - +140°F).
<b>Max breaking capacity:</b>	250 V AC. 5A - 20 W DC.	<b>Protection class:</b>	IP20.
<b>Max ignition current:</b>	5 A AC.	<b>Approvals:</b>	CE - VDE - UL File E164102.
<b>Connection:</b>	3-pin clamp, 2,5 sqmm rigid wire, max tightening torque 0,5 Nm, 1,5 sqmm flexible wire (with terminal).		

## Humidistat

DESCRIPTION	Humidistat 35/95%			1-piece pack
Code	VR3595			



**Omega adhesive support** is an accessories for fixing small devices or 35 mm pre-drilled DIN guide to EN 60715. It is possible to fix devices in a quick and easy way, without drilling. It is an easy way to install devices even in limited spaces or in case of retrofitting. Plastic adhesive element with a high bearing capacity. The industrial adhesive tape remains stable with aging and grants a good level of security.

## Support

DESCRIPTION	OMEGA adhesive support			5-piece pack
Code	VR9510			

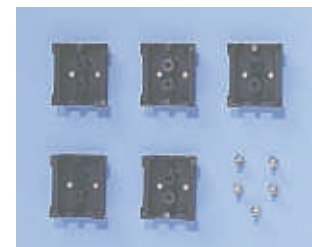

**Purge valve and Condensation absorber** to dissipate condensation in carpentry.

## Purge valve and Condensation absorber

DESCRIPTION	Purge valve: threaded joint for pressure compensation Dim. Ø 60x37mm (WxH). Protection Level IP66 EN 60 529	2-piece pack	Condensation absorber: threaded joint for drainage Dim. Ø 60x50mm (WxH). Protection Level IP66 EN 60 529	1-piece pack
Code	VR2010		VR2020	

